

## Installation and Operation Manual

# All In One Heat Pump Water Heater

Model:EL220AIO/EL220AIO-C



**This all in one heat pump is suitable for outdoor environments.**

**If the power cord is damaged, it must be replaced by a qualified person in order to avoid danger.**

# Table of Contents

## 1. Safety instructions

## 2. Product description

2.1 Product features

2.2 Working mode

2.3 Product appearance

## 3. Storage, transportation and handling

3.1 Storage and transportation

3.2 Handling

## 4. Installation

4.1 Placement space requirements

4.1.1 Installation location and space requirements

4.1.2 Electrical requirements

4.2 Installation method

4.2.1 Equipment fixation

4.2.2 Water pipe connection

4.2.3 Condensate drain pipe

4.2.4 PTR valve installation

4.2.5 Thermal expansion tank (not provided)

4.2.6 Temperature limiting device (not provided)

4.2.7 Pressure limiting valve (not provided)

4.2.8 Remote wire controller installation

4.3 Installation check points

4.3.1 Water tank position

4.3.2 Pipeline connection

4.3.3 Condensate drain hose

4.3.4 PTR valve and drain line must comply with local regulations

4.3.5 Electrical connection

4.3.6 Check the wire controller

4.3.7 Confirm whether there is a problem with the machine settings

4.4 Heat pump start-up

## **5. Controller instructions**

5.1 Precautions for use

5.2 Safety warning

5.3 Operating instructions

5.3.1 Start-up & Shutdown operation

5.3.2 Temperature setting

5.3.3 Working mode setting

5.3.4 Time setting

5.3.5 Timing setting

5.3.6 Manual forced defrosting

5.3.7 WiFi function instruction

## **6. Inspection and maintenance**

6.1 Inspection and maintenance precautions

6.2 Inspection items

6.2.1 PTR valve

6.2.2 Water tank flushing

6.2.3 Water tank emptying

6.3 Holiday and long-time shutdown

6.4 Cleaning of condensate drain pipe

6.5 Refrigerating circuit

6.6 Magnesium anode rod maintenance

6.7 Check/Replacement of magnesium anode rod

## **7. Fault code display**

## **8. Environmental protection**

## **9. Warranty**

9.1 Warranty Policy Warranty Conditions

9.2 Warranty Exclusions

9.3 Warranty Period

## **10. Information in manual**

- 10.1.1 General
- 10.1.2 Qualification of workers
  
- 10.2 Information on servicing
  - 10.2.1 Checks to the area
  - 10.2.2 Work procedure
  - 10.2.3 General work area
  - 10.2.4 Checking for presence of refrigerant
  - 10.2.5 Presence of fire extinguisher
  - 10.2.6 No ignition sources
  - 10.2.7 Ventilated area
  - 10.2.8 Checks to the refrigerating equipment
  - 10.2.9 Checks to electrical devices
- 10.3 Repairs to sealed components
- 10.4 Repair to intrinsically safe components
- 10.5 Cabling
- 10.6 Detection of flammable refrigerants
- 10.7 Removal and evacuation
- 10.8 Charging procedures
- 10.9 Decommissioning
- 10.10 Labelling
- 10.11 Recovery

## 1. Safety Information

Please read all contents of manual carefully before installing and operating this appliance.

The following safety warnings are very important, always read and obey all safety signs:

- This appliance is not intended for use by persons (including children) with reduced physical, sensory or mental capabilities, or lack of experience and knowledge, unless they have been given supervision or instruction concerning use of the appliance by a person responsible for their safety. Children should be supervised to ensure that they do not play with the appliance.
- Means for disconnection must be incorporated in the fixed wiring in accordance with the wiring rules.
- If the supply cord is damaged, it must be replaced by the manufacturer, its service agent or similarly qualified persons in order to avoid a hazard.
- Water temperature over 50 degrees Celsius will cause severe burns and even death. Children, the disabled and the elderly are at the highest risk of burns. Feel the water temperature with your hands before showering to avoid burns.
- The device must be effectively grounded.
- RCD circuit breaker must be installed.
- Don't remove, cover or damage any permanent instructions or labels from the exterior or interior of the unit panel.
- Only qualified personnel should install in accordance with local and national regulations and this guide.
- Improper installation may cause water leakage, electric shock or fire alarm.
- All electrical connections must comply with the requirements of the local power company, the local power company and this guide.
- Do not use rated fuse, otherwise it may malfunction and cause electrical fire.
- Do not insert fingers, rods or other objects into the air inlet or outlet. The fan is rotating at high speed, which may cause injury.
- Do not use flammable sprays, such as hairspray or paint, near the appliance to avoid fire.
- The unit must be fixed firmly, otherwise noise and vibration may be generated.
- Make sure there are no obstacles around the device.
- In places with strong wind (such as seaside areas), the unit should be installed in a windproof place.
- Legionella control method: at least 90% tank volume boosted to 65°C weekly.
- Appliances intended to be permanently connected to the water mains not connected by a detachable hose-set. Discharge pipe connected to the pressure-relief device is to be installed in a continuously downward direction and in a frost-free environment.

**DANGER:** Failure to operate the relief valve easing gear at least once every six months may result in the water heater exploding. Continuous leakage of water from the valve may indicate a problem with the water heater.

- The ground electrode must be well grounded.
- Make sure all electrical sockets and plugs are dry and tightly connected.

- Before cleaning, be sure to stop operation and isolate the unit (ie, turn off the isolating switch or circuit breaker). Otherwise, electric shock and injury may occur.



- Do not operate the appliance with wet hands to avoid electric shock.
- A one-way check valve and a suitable isolation valve must be installed on the water inlet side.
- Except for repair and maintenance purposes, do not turn off the power, especially in cold weather, as it may freeze the appliance when the power is turned off. Continuously powered heating Water is necessary.
- If the hot water system is not used for two weeks or more, a quantity of highly flammable hydrogen gas may accumulate in the water heater. To dissipate this gas safely, it is recommended that a hot tap be turned on for several minutes or until discharge of gas ceases. Use a sink, basin, or bath outlet, but not a dishwasher, clothes washer, or other appliance. During this procedure, there must be no smoking, open flame, or any electrical appliance operating nearby. If hydrogen is discharged through the tap, it will probably make an unusual sound as with air escaping.
- This appliance may deliver water at a high temperature. Refer to the plumbing code of Australia (pca), local requirements and installation instructions to determine if additional temperature control is required.
- For continued safety of this appliance, it must be installed, operated and maintained in accordance with the manufacturer's instructions.
- DANGER: The operation of the thermal cut-out indicates a possibly dangerous situation. Do not reset the thermal cut-out until the water heater has been serviced by a qualified person.
- The water heater will have to be installed in accordance with the requirements of AS/NZS 3500.4 or, in New Zealand, NZBC G12, and including a statement of acceptable piping materials and the insulation requirements for pipes between the collector and the container.
- An outline of the practices that must be followed to provide for the draining of the container, the expansion of water during heating, and the relief of partial vacuum.

## **2. Product information**

### **2.1 Product features**

#### **Easy to operate**

The equipment adopts the user-friendly control panel with WiFi function, which is easy for users to operate.

#### **Energy saving and environmental protection**

The equipment heats water by absorbing energy from the surrounding air and releasing it into the water stored in the tank, so it is very energy efficient. If the ambient temperature is low, the heating capacity of the heat pump will decrease, and then the auxiliary electric heater can be used as a backup. After the first heating cycle is done, the heat pump is in standby mode which means compressor and fan will not consume electricity. The heat pump in standby mode acts like a well-insulated bottle which can slow the dropping rate of water temperature. Once the water temperature is lower than re-heating trigger temperature, the heat pump will re-heat the water to your set temperature.

#### **Overheating protection**

The water tank is equipped with a thermostat protection device located above the electric heater and it is in contact with the inner tank surface. If the water temperature reaches preset temperature or there is no water in the tank due to any cause, the thermostat will automatically cut off the power circuit of the electric heater. (When the water temperature is higher than 95 °C, the manual protection device of thermostat will cut off the power supply.) If the temperature returns to the normal level later, the thermostat needs to be turned on by manual reset.



## Warnings

The cause of abnormal high water temperature must be investigated by a qualified service technician and corrective measures must be taken before the water heater is restarted.

### Automatic defrosting

In the operating state of heat pump, the equipment will automatically defrost to ensure thermal efficiency.

### Water temperature or pressure protection

For your safety, the equipment is equipped with a PTR valve. If the tank pressure reaches 850 kPa or the temperature reaches 90°C, the valve will automatically open to allow the pressure or temperature to drop to a safe value.

### Water supply pressure

The water heater is designed to be directly connected to the water system. When the water supply pressure exceeds 850 kPa, a pressure reducing valve must be installed. The minimum water supply pressure of 200 kPa is required to ensure the normal water supply of the water heater.

If the PTR valve or other safety devices has been tampered or not been installed in accordance with the instructions in this manual, the company will not be responsible for the consequences.

## 2.2 Technical Nameplate:

ENEFT All In One Heat Pump		ENEFT All In One Heat Pump	
Model	EL320AIO	Model	EL320AIO-C
Tank capacity	320L	Tank capacity	320L
Inner tank material	BTC245R steel with enamel	Inner tank material	BTC245R steel with enamel
Tank rated working pressure	800kPa	Tank rated working pressure	800kPa
Permissible excessive operating pressure	850kPa	Permissible excessive operating pressure	850kPa
Electric Element Power	2500W	Electric Element Power	2500W
Condenser	Micro-channel heat exchanger	Condenser	Micro-channel heat exchanger
PTR valve	850kPa (48kW)	PTR valve	850kPa (48kW)
Refrigerant type/Mass	R290/450g	Refrigerant type/Mass	R290/450g
Heat pump rated power input	1360W	Heat pump rated power input	1360W
Rated input (Heat Pump + ELE Heating)	3898W	Rated input (Heat Pump + ELE Heating)	3898W
Heat pump heating capacity	3300W	Heat pump heating capacity	3300W
COP	4.35	COP	4.35
Rated Voltage/Frequency	220-240V~, 50Hz	Rated Voltage/Frequency	220-240V~, 50Hz
Heat pump rated current	8.07A	Heat pump rated current	8.07A
Rated current (Heat Pump + ELE Heating)	17.04A	Rated current (Heat Pump + ELE Heating)	17.04A
Max pressure of suction side	0.95Mpa	Max pressure of suction side	0.95Mpa
Max pressure of exhaust side	3.1Mpa	Max pressure of exhaust side	3.1Mpa
Max Allowable Pressure	3.1Mpa	Max Allowable Pressure	3.1Mpa
Running ambient air temp.	-7°C ~ +47°C	Running ambient air temp.	-7°C ~ +47°C
Thermostat set point	62°C	Thermostat set point	62°C
Noise level	42dB(A)	Noise level	42dB(A)
Net Weight	145KG	Net Weight	145KG
Waterproof grade	IPX4	Waterproof grade	IPX4
Remark:	<ul style="list-style-type: none"> <li>Electrical safety certification number CCS-230185-EA</li> <li>Product conforms to AS 3498: 2020 and AS/NZS 2712: 2007</li> <li>COP testing condition: Ambient 20°C, Water Temperature 15-55°C</li> <li>For continued safety of this appliance it must be installed, operated and maintained in accordance with the manufacturer's instructions.</li> <li>Warning: This appliance may deliver water at high temperature, refer to the plumbing code of australia (pca), local requirements and installation instructions to determine if additional delivery temperature control is required.</li> <li>Serial Number:</li> </ul>	 <b>AS/NZS 2712:2007</b> Lic: SMK41328	 <b>AS/NZS 2712:2007</b> Lic: SMK41328
	 <b>WaterMark</b> <b>AS 3498:2020</b> Lic: WMK26821	 <b>WaterMark</b> <b>AS 3498:2020</b> Lic: WMK26821	 <b>WaterMark</b> <b>AS 3498:2020</b> Lic: WMK26821

### 2.3 Circuit Diagram:

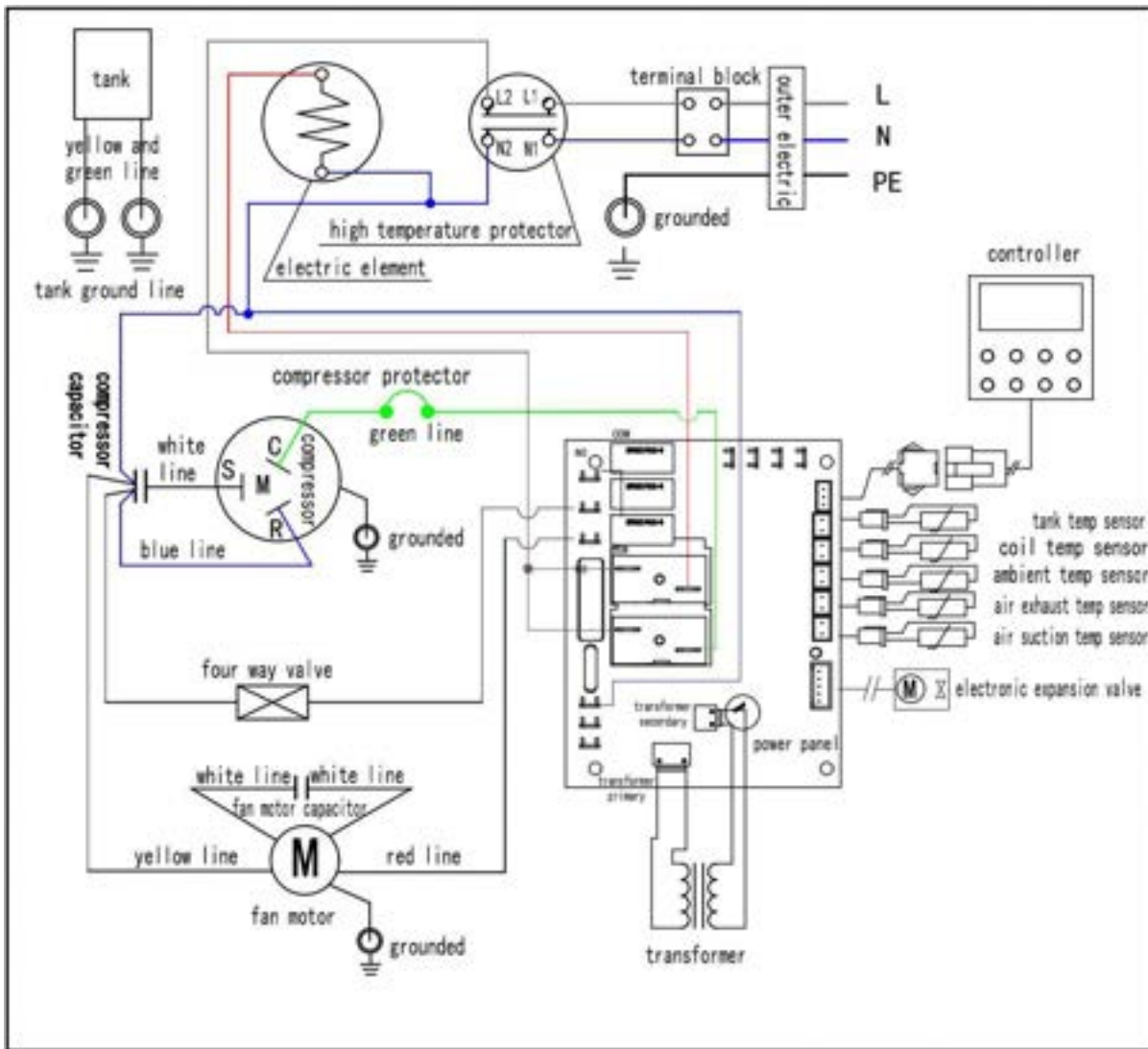

### 2.4 Working mode

- **Eco Mode:**

Only heat pump works, the water can be heated up to 60°C at maximum for model EL220AIO, the water can be heated up to 62°C at maximum for model EL220AIO-C

**Note:** if the ambient temperature is low (lower than 5 °C), the electric element will be on under Eco mode

- **Hybrid Mode:**

Both heat pump and electric element work together, the water can be heated up to 75°C at maximum for both model EL220AIO and model EL220AIO-C.

- **Bacteria killing Mode:**

Bacteria killing mode is automatically controlled by the heat pump program, which can heat up the water to 65°C once a week. Before 60°C, only heat pump works to heat up the water. After 60°C, the electric element starts working.

**Note:** The default hot water outlet temperature is 60°C.



## 2.5 Product appearance

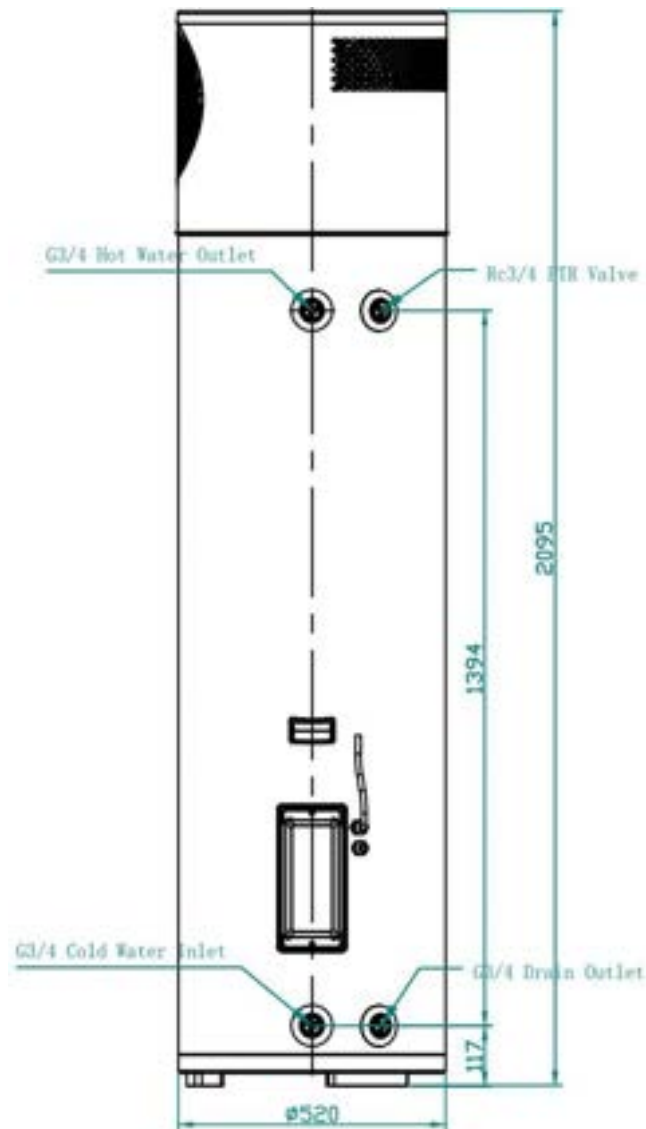

## 3. Storage, handling, transportation and installation

### 3.1 Storage and transportation

As a rule, the equipment should be packed erectly and the water tank be stored or transported as an empty water tank. For short-distance transport, care should be taken to allow a tilt angle of 30° at maximum. Whether transported or stored, the ambient temperature should be in the range of -20 °C~+60°C.

### 3.2 Handling

When handled and transported by a forklift, the equipment must be fixed to the pallet at all times. The lifting rate should be kept at the lowest limit. Due to the top-heavy weight, anti-overturn measures must be taken. To prevent any damage, the equipment must be placed on a level surface!

For handling, it must be noted that the maximum allowable tilt angle cannot exceed 15°. If tilting cannot be avoided during handling and transportation, the equipment can only be operated one hour after being moved to the final vertical position.



## Warnings

### Damage during transportation!

- ✧ Avoid tilting the device over 15°.
- ✧ Be careful when handling equipment.
- ✧ To avoid dropping the equipment and damaging internal components, do not turn the equipment.
- ✧ To avoid equipment damage, the protective packaging shall be removed after the equipment has been transported to the installation site.
- ✧ Use straps to prevent the equipment from being scratched.
- ✧ Use the appropriate means of transportation to transport the equipment to the installation site (special vehicle, pallet truck, etc.)

## 4. Installation

The manufacturer's warranty does not cover any damage caused by improper installation, connection or use of any type of accessory (except as listed in this user manual) of this water heater.

The use of unauthorized devices may shorten the life of the water heater and may result in death and property damage. The manufacturer is not responsible for any loss or damage caused by the use of such unauthorized devices.

### 4.1 Placement space requirements

Installation space requirements: to avoid affecting airflow, please ensure the equipment space requirements as shown.

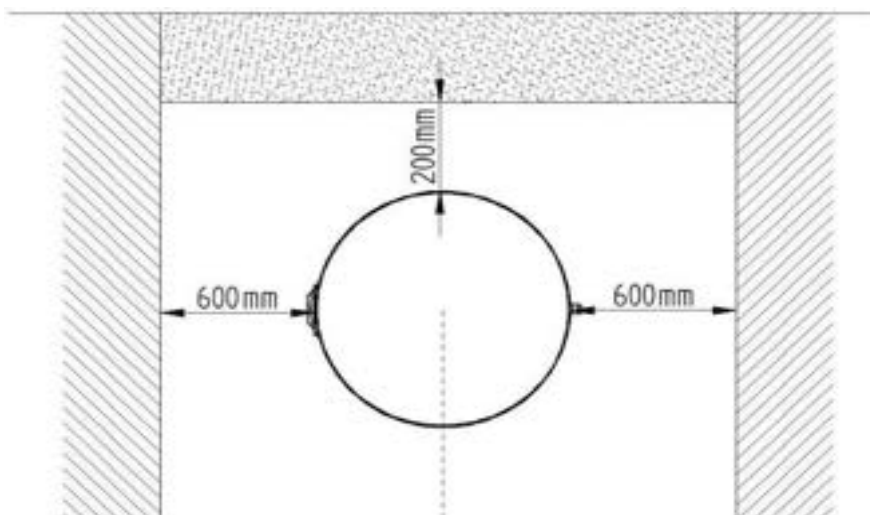

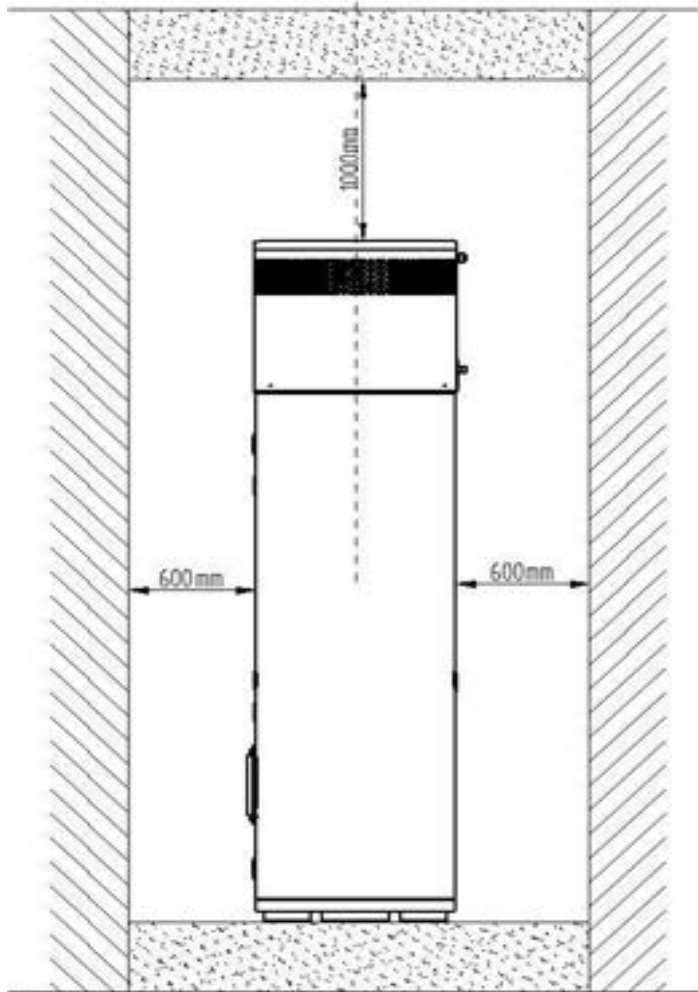

## Warning

**PTR valve coming with the equipment must be installed and the valve outlet must not be blocked, as this may be dangerous.**

### 4.1.1 Installation location and space requirements

The water heater shall be installed in a clean place that is as close as possible to the area with the maximum hot water demand. The long non-insulated hot water pipes will waste energy and water.

When the water heater is placed, the space that is used for proper maintenance must be reserved, that is, the space required for removing the top cover, accessing to the PTR valve, and removing & installing the anode rod.

The entire equipment may be disassembled for future maintenance, so the water heater and water pipelines should be protected to prevent damage caused by severe cold and corrosive environments.

In the place where the water heater is installed, there must be sufficient drainage facilities, such as floor drains, to drain the water in the tank when the tank is repaired or cleaned.



## **Warning**

The water heater should not be installed in areas with corrosive atmospheres (such as the areas for storing chemicals and flammable liquids or releasing aerosols). When using this equipment, these corrosive, flammable vapors may be brought out from the storage area due to convection of air in the room or other confined space. Any arc that may be generated at the electrically controlled live part of the water heater may ignite these vapors, thus causing an explosion or fire that could result in severe burns or even death and property damage.

### **Suggestions**

Even if the equipment is running at a low level of noise, it is best to install it away from the bedroom or other resting place.

### **Condensate discharge**

The condensate produced by the water heater needs to be discharged, so there must be a drainage device close to the water heater.

## **4.1.2 Electrical requirements**

### **Power requirements**

The power cord parameters are: 3 X 2.5mm<sup>2</sup> or above.

This water heater must be directly connected to the main power supply of 220V-240V~ / 50Hz.



## **Warning**

All electrical installation and wiring must be performed by qualified personnel in accordance with the wiring rules required by local authorities.

The water heater needs to be connected to the user's power supply line through the earth leakage protective device. It must be noted that the user's power supply line must have a grounding wire.

The earth leakage protective device is not waterproof, and it should pay attention to preventing water flowing in when used.

Correct grounding connection is essential. The presence of water in pipes and water heater can not provide sufficient grounding conductivity. Non-metallic pipes, dielectrics, flexible connections, etc. may cause the water heater to be electrically isolated.

The electrical components and insulation tests in the water heater must be performed between the live wire and ground wire, as well as the null line and the ground wire. The test between the live wire and the null line will destroy the electronic components.

## 4.2 Installation method

### 4.2.1 Equipment fixation

- 1) Remove the package and external protective packaging
- 2) Place upright on the ground, with a 10cm foot pad under it. the installation site has a solid foundation and must be able to withstand a weight of more than 500kg. Not to be hung on the wall.
- 3) A durable fixed ring must be needed and fix with bolts firmly to prevent typhoon weather. The size of fixed ring is 1600mm(length)x50mm(width)x0.8mm(thickness), the size of bolts:M8x50mm.

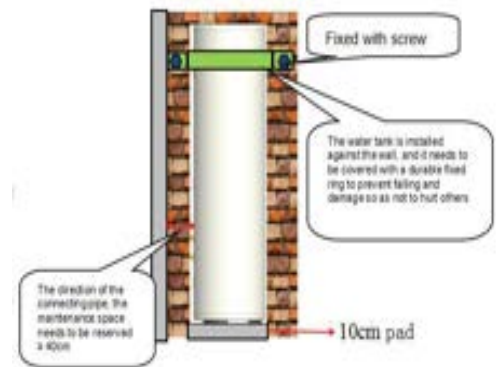

### 4.2.2 Water pipe connection



## Warning

**All piping work must be performed by qualified personnel in accordance with the requirements of local laws and regulations.**

**Care must be taken not to touch the pipelines as the temperature may be very high.**

**The supplied PTR valve must be installed, otherwise damage to the equipment or other property loss may be caused.**

Installation of the inlet and outlet water pipelines: the inlet and outlet water threads are G3/4 (female thread). Pipelines must be high temperature-resistant, durable and weathering-resistant (outdoor installation).

Installation of PTR valve pipeline: The thread specification of the valve is G3/4 (male thread).

All pipelines should be insulated with suitable thermal insulation materials (if exposed, they must be weathering and UV-resistant) to optimize energy efficiency.

It is vitally important to scrupulously clean the pipeline before installing the pressure reduction valve, to prevent any small element or impurity from altering its correct operation. It is also highly recommended to install a filter at pressure reduction valve inlet for protection. This should be installed in a horizontal pipe; the direction of flow must correspond to the direction shown by the arrow on pressure reduction valve body. After installation, test the water pressure, and adjust the regulator if necessary. To adjust, loosen the locknut on the adjustment screw, then turn the screw up or down until the water pressure is at the desired level, as measured by a pressure gauge attached to a threaded hose bib somewhere in the home.



## Warning

- ✧ First inject cold water into the tank before the commissioning of the equipment.
- ✧ Open the water outlet connection and one or more hot water taps.
- ✧ Open the cold water inlet of the storage tank, start injecting water into the water tank.
- ✧ Turn off the hot water tap when there are no air bubbles in the water stream.
- ✧ Connect the equipment to the power supply via the power cord.

### Water quality requirements

Poor water quality will lead to a shortened product life. The magnesium rod shall be checked more frequently and replace it if necessary.

#### 4.2.3 Condensate drain pipe

This water heater has an integrated condensate water pan. The water collected in the water pan is drained from the drain hole at the back of the water heater and its connected hose.

- ✧ Connect one end of the condensate drain pipe to the drain hole on the back of the water heater.
- ✧ The other end is directly connected to the floor drain.

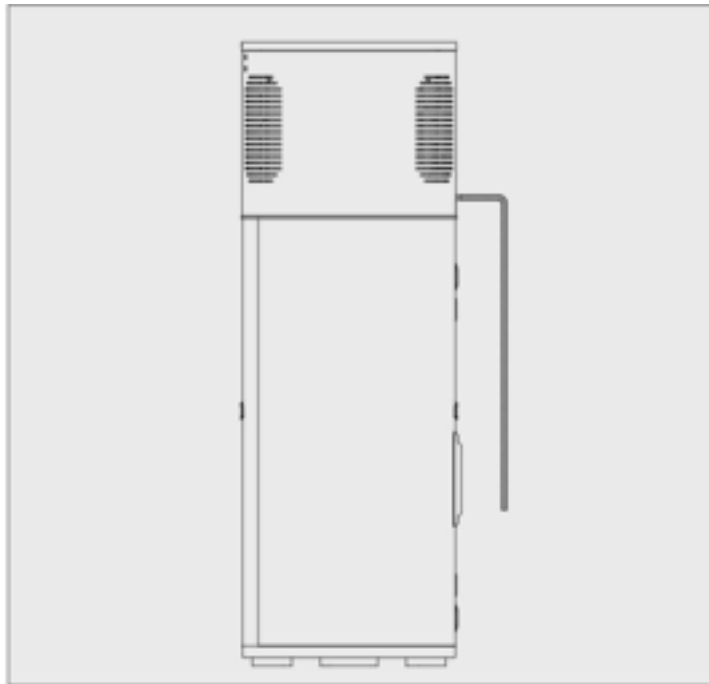

#### 4.2.4 PTR valve installation

The PTR valve must be installed at the connection port marked "PTR valve" on the water heater. No other valve body or any other type of part should be installed between the PTR valve and the water tank. Please install the PTR valve correctly according to this valve's instruction manual.



## Warning

The pressure rating of the PTR valve must not exceed 850 kPa.

**The pressure relief device of the PTR valve shall be operated at least ONCE EVERY SIX MONTHS. When the operating lever is running, if the water cannot be discharged smoothly, the authorized relevant technician shall inspect the PTR valve or replace the PTR valve if necessary.**

**The PTR valve and its drain pipe must not be sealed or blocked. When heating the water, a small amount of water is allowed to leak from the PTR valve.**

**Once the PTR valve is installed on the water heater, its function is to discharge high temperature hot water under certain conditions. Therefore, it is highly recommended that the pipeline that connects the PTR valve can withstand temperatures higher than 99 °C. Failure to follow this advice can lead to dangerous situations.**

**Never block or seal the PTR valve or its drain outlet for any reason. If the PTR valve is changed arbitrarily or not installed in accordance with the instruction manual, the warranty will be invalid. It is recommended to connect a hose from the PTR valve outlet to the floor drain or a suitable drain device so that the drained water will not touch any electrical part, person or animal, thus eliminating any other possible risks.**

**In order to reduce the risk of excessive pressure or temperature in the water tank of the water heater, a PTR valve is required to be installed as the protection device as per the local laws and regulations.**

#### **4.2.5 Thermal expansion tank (not provided)**

Thermal expansion is a natural process in which the volume of water is increased after it is heated. When the volume increase of the water stored in the water tank is limited, it will cause an increase in pressure. Increased pressure can lead to dangerous situations. If the safety settings on the PTR valve are already in place, the valve will act during the heating cycle. Generally, if the pressure in the tank reaches the nominal value of the valve, the excessive expansion may cause the valve to malfunction prematurely and accelerate the actuating force of the valve.

Therefore, it is recommended to install an expansion water tank to alleviate this kind of excessive pressure and avoid repetitive PTR valve action.

For more information on this issue, please consult the relevant professional or water heater supplier.

#### **4.2.6 Temperature limiting device (not provided)**



### **Warning**

**The water heater can heat the water to a temperature that may lead to scalds.**

It is recommended to install a temperature limiting device at the water heater and hot water outlet in the bathroom or similar location to reduce the risk of scalds.

#### **4.2.7 Pressure limiting valve (not provided)**

If the tap water supply pressure exceeds the product's pressure rating 850kPa, a pressure limiting valve is required to be installed at the water inlet pipeline.

If the tap water supply pressure is lower than the product's pressure rating 200kPa, a pressure increasing valve is required to be installed at the water inlet pipeline to provide the necessary pressure or reduce the generation of bubbles in the water system.

#### **4.2.8 Remote wire controller installation**

Disassemble the back cover of the power cord, pull out the communication cable connector, and plug it into the communication cable connector of the wire controller.

### **4.3 Installation check points**

#### **4.3.1 Water tank position**

- ◇ The installation space must be at least 3m x 3m x 2.5m (22.5m<sup>3</sup>). If it cannot be satisfied, window-blinds or similar ventilation devices are required.
- ◇ The air inlet and outlet of the water heater shall be 1000mm away from the wall at least.
- ◇ The front and back of the water heater should be unobstructed and clean.
- ◇ The bottom of the water heater must be flat, otherwise spacers need to be added.

#### **4.3.2 Pipeline connection**

Inject tap water into the water tank after the water pipes are connected and check if there is water leak at each joint.

#### **4.3.3 Condensate drain hose**

The condensate drain hose should be connected to the drain hole of the water pan and the floor drain, drain device or drain pump.

#### **4.3.4 PTR valve and drain line must comply with local regulations**

#### **4.3.5 Electrical connection**

- ◇ Electrical connections shall not obstruct the removal of the inlet and outlet air grids.
- ◇ All electrical connections require insulating treatment.

#### **4.3.6 Check the wire controller**

- ◇ Verify whether each operation button on the control panel is flexible and displays normally
- ◇ Check whether the mode, temperature, time, and other function settings are correct. The default temperature is set to be 60 °C

#### **4.3.7 Confirm whether there is a problem with the machine settings**

Start up the water heater after confirming that there is no problem with the settings. Please pay attention to protecting the control panel.





## Warning

**The power supply cannot be activated before the water tank is filled with water.**

### 4.4 Heat pump start-up

After the water heater is installed and all electrical and water connections are also determined and checked, it should be filled with water (the water tank is ensured to be filled with water by opening the hot water tap at somewhere in the home for drawing off water). Once the tank is filled with water and powered, the user must press the power button on the wire controller to start the equipment. The startup process is as follows.

Time	Heat Pump	Notes
0---110 seconds	The water heater is with no action	Prevent compressor from damage.
110---170 seconds	Solenoid valve opens	
170---180 seconds	Fan starts	
180 seconds later	Compressor starts	High-efficient heat pump heating.

The ambient temperature range for heat pump operation is  $-5\text{ }^{\circ}\text{C} \sim 43\text{ }^{\circ}\text{C}$ . If the ambient temperature is outside this range, the heat pump will not operate and the auxiliary electric heater will start to heat the water instead of the heat pump. It will return to the heat pump mode when the ambient temperature restores to the operating temperature range of the heat pump.

## 5. Controller instructions

### 5.1 Precautions for use

If any insulation material or covering is applied on the outside of the water heater, the following points need to be noted:

- ✧ Do not cover the PTR valve.
- ✧ Do not cover the lid of the auxiliary electric heater.
- ✧ Do not cover the operation, warnings and other marks on the water heater.
- ✧ Do not cover the air inlet and outlet.
- ✧ Do not cover the control unit of water heater.

### 5.2 Safety warning



## Warning

**Do not turn on the water heater if the cold water supply switch is off.**

**Turn off the power if the water heater is overheated or subject to fire, flood or other physical**

damage.



The installation, commissioning, maintenance and cleaning of the water heater must be completed by professional technicians or maintenance personnel.

### 5.3 Operating instructions

#### Control panel





#### 5.3.1 Start-up & Shutdown operation

- Power on: press “” to start it up.
- Power off: press “” to shut it down.
- Press “” for over 3 seconds to lock or unlock the control panel.

#### 5.3.2 Temperature setting





- Press “” or “” to set the temperature and adjust temperature.

#### 5.3.3 Working mode setting

- Press “” to switch to Eco mode or Hybrid mode.
- When “” is displayed, It's Eco mode. Only heat pump works.
- When “” is displayed, It's Hybrid mode. Both heat pump and electric element work.

**Note: It will switch to Eco mode automatically after Hybrid mode is finished.**











#### 5.3.4 Time setting

- Press “” to set time as follows: hour -minute-quit.
- Press “” and “” to set the time details.
- During the set process, you can press “” to quit.

**Note: the time shown on the controller may not be exactly the local time. Please manually change the time before using the timer function.**

#### 5.3.5 Timer setting



- Press “” for come into the setting.

- Timing 1: timing 1 flicks, press “” and “” to set hours, and press “”; timing 1 flicks, and press “” and “” to set the minutes, and press “” to quit.
- Timing 2: press “” to come into timing 2, and operation is as the same as timing 1.
- Press “”, then press “” and “” to select timing 1 or timing 2, then press “” to cancel timer setting.

Note: Information below is about how timer function works

If you set a timer for a certain period, during this period the heat pump will keep checking the water temperature itself. If the water temperature falls below the re-heating trigger temperature, the heat pump will reheat the water to your set temperature. If not, the heat pump will be in stand-by mode. When the time is beyond the set period, even the water temperature is lower than the re-heating trigger temperature, the heat pump will not work.

### 5.3.6 Manual forced defrosting

- Press “” and “” for over 5 seconds, then the defrosting is forced to start, and the maximum defrosting time is reached or the protection fault exits.

### 5.3.7 WiFi function instruction

#### • Download and Install the App

1 ) Scan the QR code to download the "Smart Life" application or download the application in the application store by mobile phone, and then install the application. (Available for Android and iOS system)



## 2) Sign up

After installing the app, press the "  " icon and open the Smart Life app, if there is no account, should sign up at first time, refer to following process:

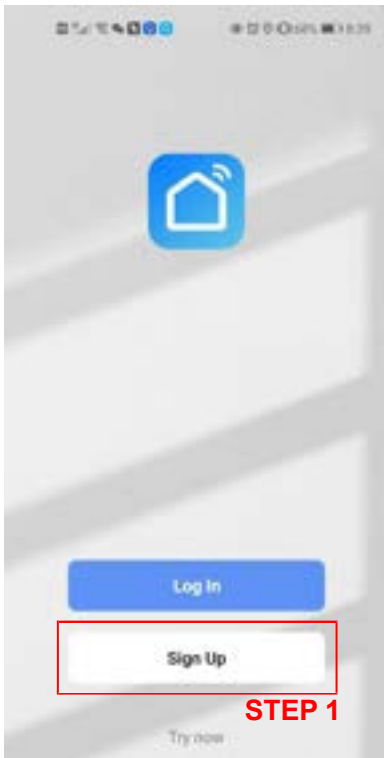

**STEP 1**

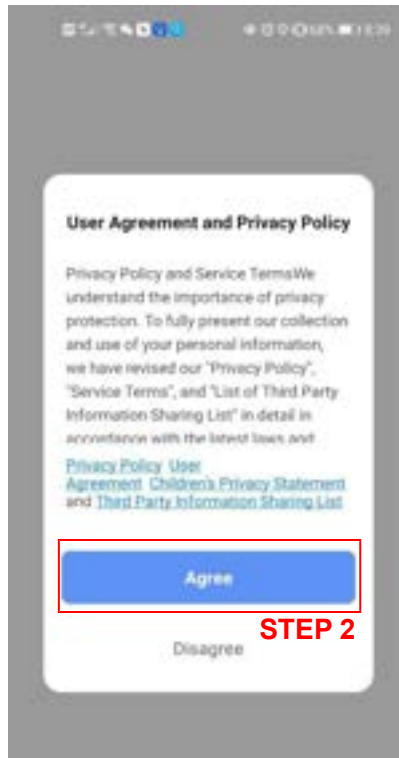

**STEP 2**



**STEP 3**

select country, input mobile number  
select I Agree then get the  
verification code

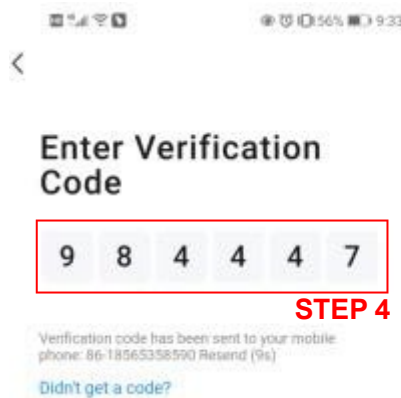

**STEP 4**

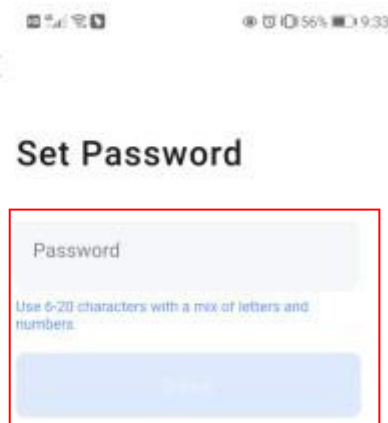

**STEP 5**

## 3) Log in

After signing up, log in the application refer to following process:

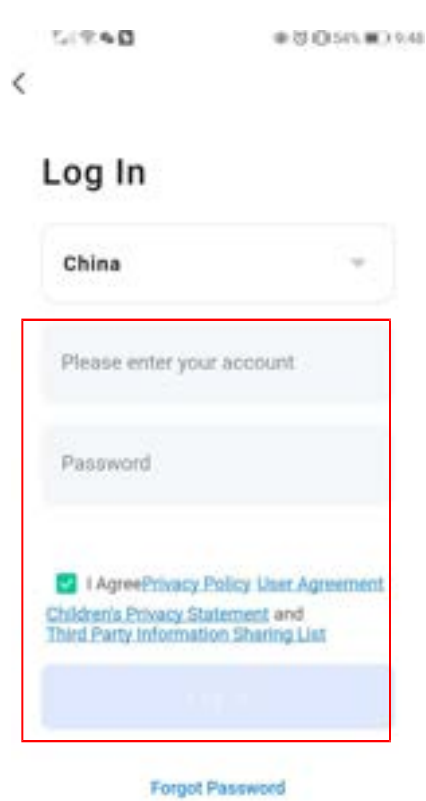
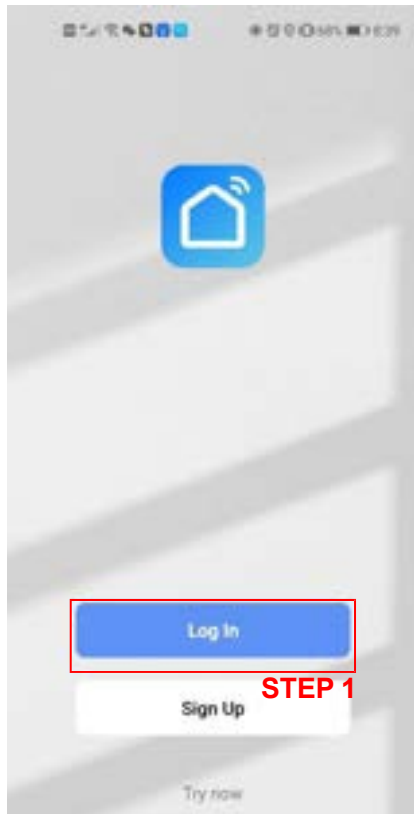

**STEP 2**  
**Input account and password**  
**and log in**

4) Create home

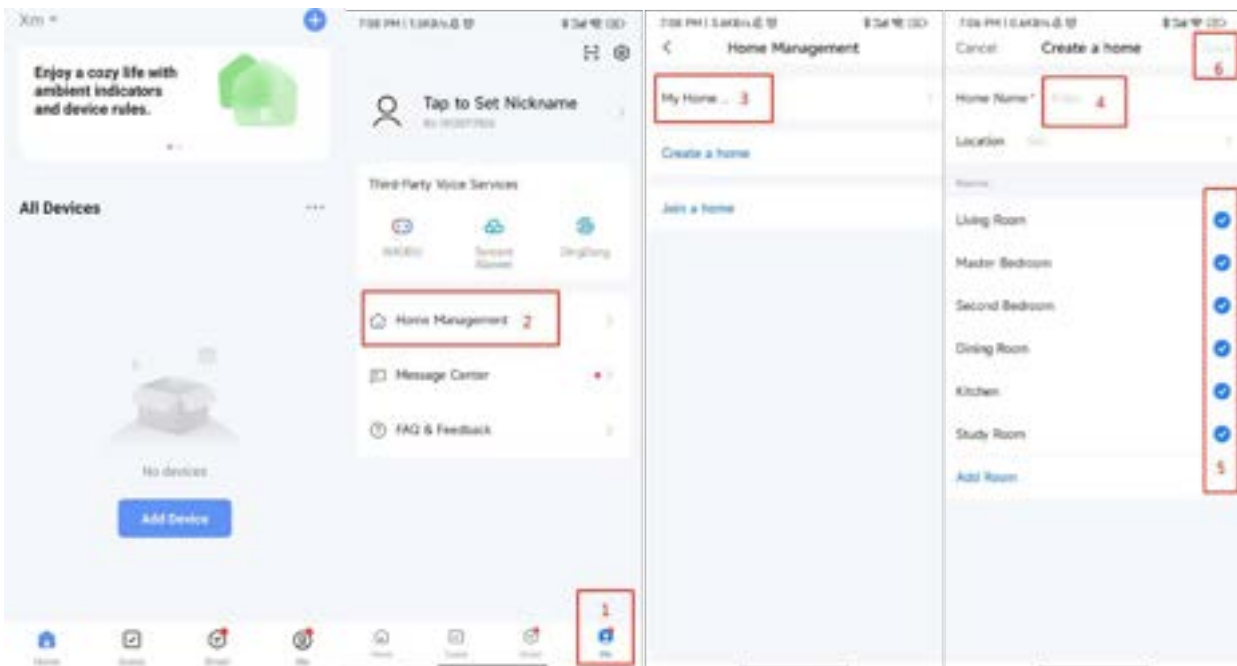

After signing up, should create "home", refer to following process:

Home Management → Set home name → Set location → Add room → Save



● **Connect the WIFI**

<https://drive.google.com/file/d/1iYg5bsdcnQl--mrglWk3INV67M9zrf3H/view?usp=sharing> for video guide "How to connect our phone to the heat pump"

- 1) Press and hold the two keys  and  for 5s, enter into manual intelligent distribution network connection, within 3 minutes, wait for connecting, the symbol "  " will flash, after three minutes, exit connecting automatically if failed in connecting.
- 2) Use mobile phone connect the WIFI hot spot, the hot spot should be available for internet.



- 3) Open the app Smart Life and log in, press the icon " + ", or press " Add Device "
  - find " Large Home Appliance "
  - select the " Smart Heat Pump (Wi-Fi) "
  - enter into WIFI connecting interface, input the WIFI password ( the WIFI account must be same as the WIFI which mobile phone connected),
  - press " next "
  - press the " Confirm the indicator is blinking. "
  - select the " Blink Quickly"
  - Wait for finding device, until the device appeared
  - press " + " to add the device, and give a new name of this device if need.
  - finish adding device, shows the operation interface.

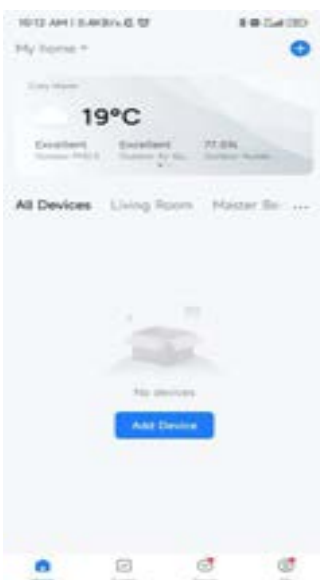

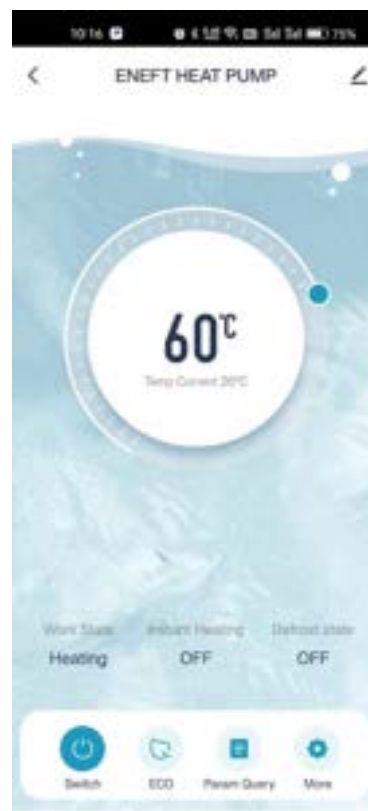
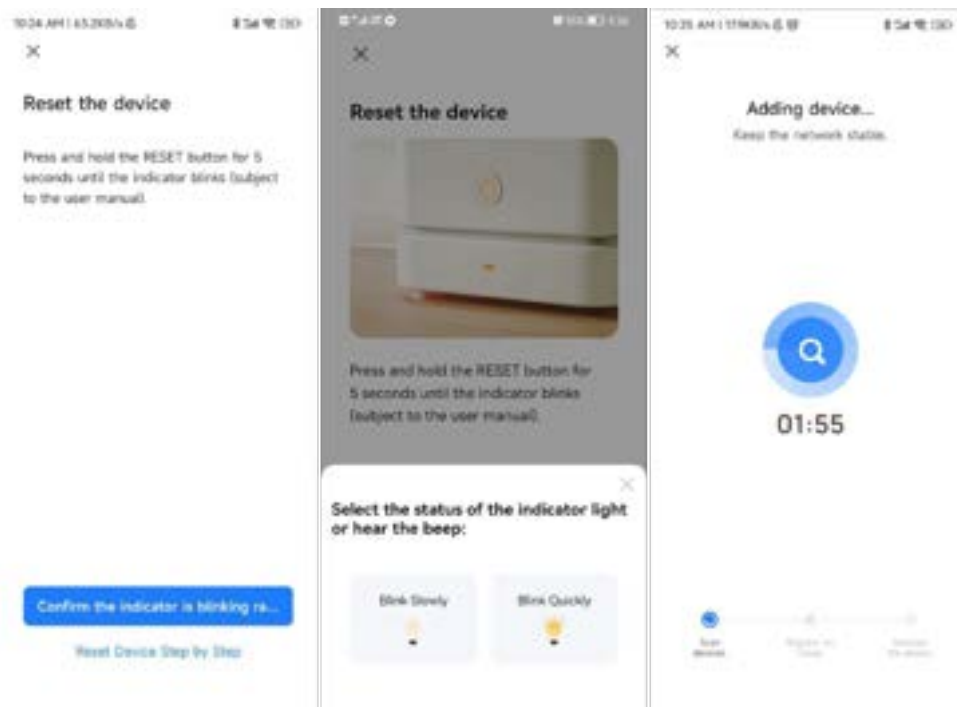

• **Operation**

- 1) Set water temperature



Move the circle to change the water temp setting

2) Mode change

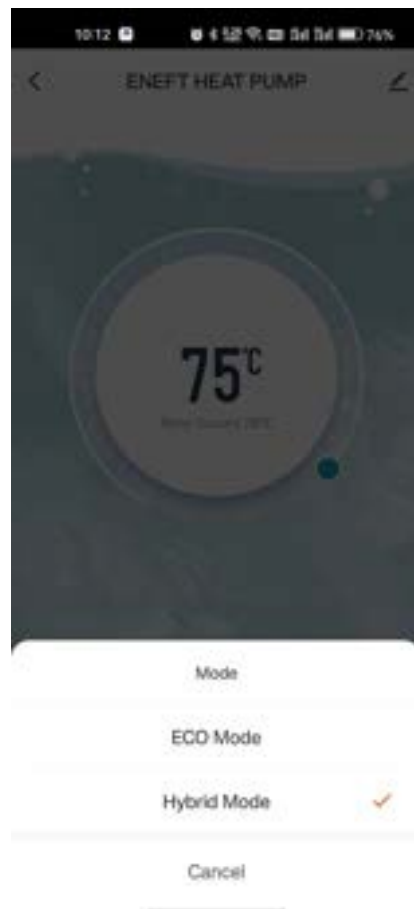

Press this key to choose working mode you want



### 3) Set timer

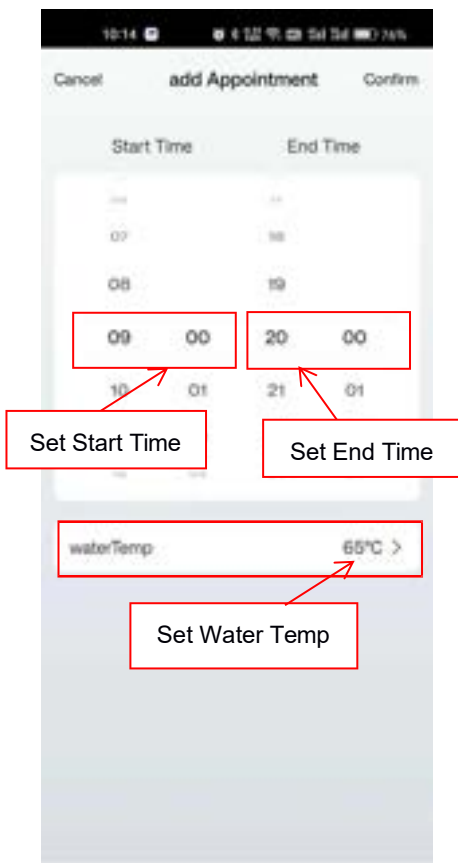
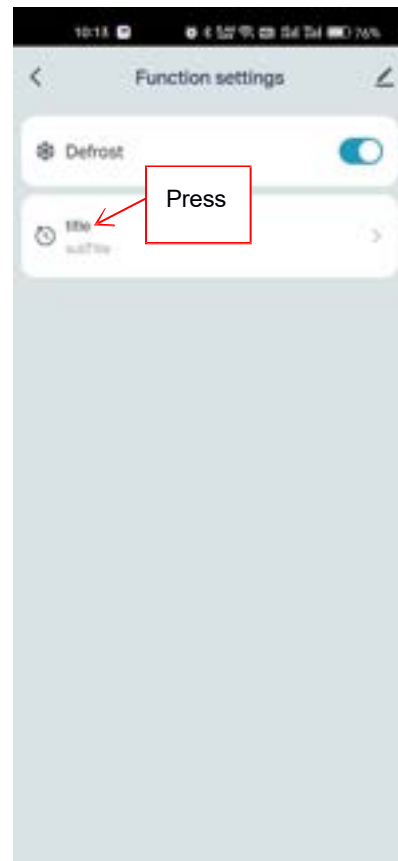
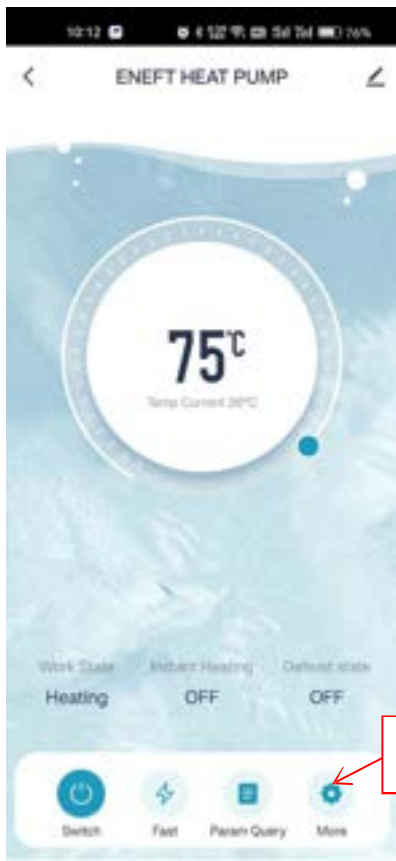

## 6. Inspection and maintenance



### Warning

The water heater should be repaired and maintained by professionals in accordance with local plumbing standards.

Before manually operating the PTR valve, make sure that no one will be exposed to danger because of contacting the hot water released by the valve. The water may not heat up to the level of scald, however it is still necessary to use a suitable drain pipe to release the water to avoid possible injury or property damage.

Periodic release of the PTR valve is part of normal operation. This is because there is thermal expansion in a closed water system that causes an increase in pressure. If such release becomes excessively frequent and continuous, please contact the after-sales service provider and don't block the outlet of the valve.

**Note:** Proper maintenance of the water heater will provide a longer, reliable, trouble-free and economical operating life.

It is recommended to establish a regular preventive maintenance program for the users to follow up.

### 6.1 Inspection and maintenance precautions

It is recommended that periodic inspections of the controller, heating elements, and wiring should be performed by qualified electrical service personnel.

It is recommended that the evaporator and refrigeration circuit be inspected and cleaned every 5 years for dust and residue. In dusty environments, they should be inspected and cleaned more frequently.

### 6.2 Inspection items

#### 6.2.1 PTR valve

The lever handle of the valve should be lifted and released at least once every 6 months to ensure flexible operation of the valve.

A few liters of water shall be allowed to drain from the valve so as to flush the valve body, but the drained water should be connected to an external drainpipe to flow to the floor drain.

It is strictly forbidden to replace the existing PTR valve with a PTR valve that is higher than the pressure rating specified by the water heater.

If the valve body cannot drain water when the release lever is opened or it cannot be well sealed when the release lever is closed, it must be promptly replaced by a professional.

The PTR valve can not be repaired.



## **Warning**

Before manually operating the PTR valve, make sure that no one is exposed to the hot water released by the valve body. The hot water discharged from the water tank may not be sufficient to cause scalds, but should be connected directly to an appropriate drain place to prevent injury or damage.

### **6.2.2 Water tank flushing**

The suspended solids in water are easily deposited at the bottom of the tank. Therefore, it is normal to have hard water sediments at the bottom of the tank.

It is recommended to periodically drain the water and then inject water into the water tank to wash the sediments at the bottom of the tank every 6 months.

### **6.2.3 Water tank emptying**



## **Warning**

**Please turn off the power of the water heater before draining the water.**

### **Risk of scalds!**

**Please check the hot water temperature of the water heater before opening the PTR valve. Until the water temperature drops to a level that is insufficient to cause scalds or other injuries.**

Discharge water from the drain outlet, where a large amount of water will be drained. To ensure proper drainage, the following points need to be noted:

- ✧ Close all hot water taps.
- ✧ Isolate cold water supply.
- ✧ Remove the cold water inlet connection until the drain is stopped.
- ✧ Open a hot water tap.
- ✧ Wait until all the water is drained.

### **6.3 Holiday and long-time shutdown**

If the water heater will be kept idle for a long period of time, in order to save energy, the power and water supply of the equipment should be turned off.

Although the water heater has an antifreeze function, if the water heater and pipeline may be subjected to freezing temperatures, both of them should be drained. After a long period of shutdown, the operation and control of the water heater should be checked by qualified maintenance personnel. Make sure the water heater is completely filled with water before running the water heater.

#### 6.4 Cleaning of condensate drain pipe

The condensate drain outlet is located on the back of the water heater. If it is clogged, water will overflow from the outside of the water heater, so it is necessary to regularly clean and clear the condensate drain outlet.

- ✧ Remove the condensate drain pipe.
- ✧ Clear and unblock the debris and attachments from the drain outlet.
- ✧ Periodically inspect the drain pipe and remove any debris that may gather in the drain pipe.

#### 6.5 Refrigerating circuit



#### **Warning**

**Repairs to the refrigeration system circuits (e.g compressors, tank coils, evaporators, thermal expansion and solenoid valves, etc.) can only be carried out by authorized after-sales service providers.**

#### 6.6 Magnesium anode rod maintenance

The magnesium anode rod of water heater is the most important protective part against corrosion and premature failure for any water tank.

Therefore, it is very important to check the magnesium anode rod. It is generally recommended by the water heater industry to check the anode rod once a year.

Apartments that supply salty or softened water should consider being inspected more frequently. If there is any doubt, please consult your local plumbing expert.

If necessary, please contact an authorized person to inspect and replace the magnesium anode rod.

#### 6.7 Check/Replacement of magnesium anode rod

The tank of the water heater shall be protected against corrosion by an internal magnesium anode rod.



#### **Warning**

**Damage caused by the water heater operation without the protection of magnesium anode rod is not covered by our warranty.**

**It needs to check the magnesium anode rod every year and replace the magnesium anode rod if necessary.**

The inner wall of the water storage tank is coated with an enamel coating, which is only used for the

corrosion protection of normal water quality. When more corrosive water is used, the protection can only be effective if additional safety measure (anode rod) is taken and the magnesium rod is checked more frequently.

**Check the protective magnesium anode rod:**

- ✧ Disconnect the water heater from the power supply.
- ✧ Turn off the water supply.
- ✧ Remove the magnesium anode rod.
- ✧ Perform a visual inspection and replace it if necessary.
- ✧ It is recommended to replace the anode magnesium rod at least every 2 years.

**7. Fault code display**

Installation, maintenance and repairs can only be carried out by an authorized service supplier. The fault codes and handling measures are listed in the following table:

Error Code	Error Contents	Solution
E01	Water tank sensor failure	Secure the connector or replace the sensor
E02	Ambient sensor failure	Secure the connector or replace the sensor
E03	Heat exchanger sensor failure	Secure the connector or replace the sensor
E05	System high voltage protection	Check the circulation pump and pipeline, lack of refrigerant
E06	System low voltage protection	Check for lack of refrigerant, check if the fan is working
E10	Communication failure	Check communication line, line sequence, connector, type
E14	High exhaust gas temperature protection	Check if the exhaust temperature exceeds the set value
E16	Exhaust gas sensor failure	Secure the connector or replace the sensor
E18	Air suction sensor failure	Secure the connector or replace the sensor
E38	Water tank zero celsius degree anti-freeze protection	Check the water tank temperature sensor, note that the resistance value is 5K
E39	EEPROM system failure	Parameters must be restored to factory settings

**8. Environmental protection**

Environmental protection is our basic corporate strategy. For us, the quality of products, our benefits and environmental protection are all equally important goals, and laws and regulations on environmental protection must be strictly observed. We will try our best to use the best technologies and materials under the premise of protecting the environment.

**Package**

We participate in the recycling programs of various countries to ensure optimal recycling. All our

packaging materials are environmentally friendly and recyclable.

### **Old equipment**

The old equipment containing valuable materials should be recycled. These components can be easily separated and composited and also marked accordingly. Therefore, these components can be classified and further recycled or disposed of.

Prior to the end of the service life of this equipment, the personnel who have operational qualifications to the refrigeration circuit must recycle the refrigerant from the sealing system based on the preferred consideration of environmental protection.

## **9. Warranty**

### **9.1 Warranty Policy Warranty Conditions:**

- (1) The ENEFT all in one heat pump must be installed in accordance with the installation instructions supplied with the all in one heat pump , and in accordance with all relevant statutory/local requirements of the state/province/municipality in which the water heater is installed.
- (2) Where a failed component or all in one heat pump is replaced under warranty, the balance of the original warranty period will remain effective. The replaced part or all in one heat pump does not carry a new warranty.
- (3) Where the all in one heat pump is installed in a position that does not allow safe, ready access, the cost of accessing the site safely, including the cost of additional materials handling and/or safety equipment, shall be the owner's responsibility.
- (4) The warranty only applies to the all in one heat pump and original or genuine (company) component replacement parts and therefore does not cover any plumbing or electrical parts supplied by the installer and not an integral part of the all in one heat pump . Such parts would include pressure regulating valve, isolation valves, check valves, electrical switches, pumps or fuses.
- (5) The all in one heat pump must be sized to supply the hot water demand in accordance with the guidelines in the ENEFT all in one heat pump Literature.
- (6) This warranty is for parts only, any and all labor costs associated with diagnosis, removal of the faulty part and installation of replacement parts will solely be the owner's responsibility.

### **9.2 Warranty Exclusions:**

- (1) Repair and replacement work will be carried out as set out in the ENEFT all in one heat pump warranty. However the following exclusions may void the warranty and may incur additional service charges and/or cost of parts.

- (2) Accidental damage to the all in one heat pump or any component, including: Acts of God, failure due to misuse, incorrect installation, attempts to repair the water heater other than by a ENEFT accredited service agent or the ENEFT service department.
- (3) Where it is found there is nothing wrong with the all in one heat pump; where the complaint is related to excessive discharge from the temperature and/or the pressure relief valve due to high water pressure; where there is no flow of hot water due to faulty plumbing; where water leaked are related to plumbing and not the all in one heat pump or its components; where there is a failure of electricity or water supplies; where the supply of electricity or water does not comply with relevant codes or acts.
- (4) Where the all in one heat pump or its component has failed directly or indirectly as a result of excessive water pressure.
- (5) Overflow vent drain has not been installed or blocked or corroded.
- (6) Where the Heat Pump has rusted as a result of a corrosive atmosphere.
- (7) Where the unit fails to operate or fails as a result of ice formation in the piping to or from the all in one heat pump .
- (8) Where the all in one heat pump is located in a position that does not comply with the all in one heat pump installation instructions or relevant statutory requirements, causing the need for major dismantling or removal of cupboards, doors or walls, or use of special equipment to bring the all in one heat pump to floor or ground level or to a serviceable position.
- (9) Repair and/or replacement of the all in one heat pump due to scale formation above 200ppm (water hardness) in the waterways or the effects of either corrosive water or water with a high chloride or low PH level when the water heater has been connected to a scaling or corrosive water supply or a water supply with a high chloride or low PH level as outlined in the Owner's Guide and Installation Manual.
- (10) Warranty service is provided to the original owner of the equipment only.

Subject to any statutory provisions to the contrary, this warranty excludes any and all claims for damage to furniture, carpets, walls, foundations or any other consequential loss either directly or indirectly due to leakage from the all in one heat pump, or due to leakage from fittings and/or pipe work of metal, plastic or other materials caused by water temperature, poor workmanship or other modes of failure.

### **9.3 Warranty Period:**

Subject to the warranty conditions and exclusions stated above, your ENEFT all in one heat pump is warranted in a residential application as follows:

Heat pump unit : ENEFT warrants all parts labour on the ENEFT water heater system for a period of 2 years from date of installation.

Water Tank unit: Labour costs are paid directly to the servicing contractor per the payment cost schedule published by ENEFT and revised from time to time at ENEFT requirement. ENEFT warrants that the tank will be free from defects for 5 years at 100% replacement, and for a further 1 years under a pro-rated scale, culminating in warranty end after 6 years from date of installation.

## 10. Information in manual

### 10.1.1 General

The following information shall be specified in the manual where the information is needed for the function of the manual and as applicable to the appliance:

- information for spaces where refrigerant pipes are allowed, including statements
  - that pipe-work shall be protected from physical damage and, in the case of **flammable refrigerants**, shall not be installed in an unventilated space, if that space is smaller than  $A_{min}$  in Annex GG, except for **A2L refrigerants** where the installed pipes comply with 22.116. In case of field charge, the effect on **refrigerant charge** caused by the different pipe length has to be quantified;
  - that compliance with national gas regulations shall be observed;
  - that mechanical connections made in accordance with 22.118 shall be accessible for maintenance purposes;
  - that, for appliances containing **flammable refrigerants**, the minimum floor area of the room shall be mentioned in the form of a table or a single figure without reference to a formula;
- the **maximum refrigerant charge** ( $m_{max}$ );
- information for handling, installation, cleaning, servicing and disposal of refrigerant;
- a warning to keep any required ventilation openings clear of obstruction;
- a notice that servicing shall be performed only as recommended by the manufacturer;
- a warning that ducts connected to an appliance shall not contain a **potential ignition source**;

### 10.1.2 Qualification of workers

The manual shall contain specific information about the required qualification of the working personnel for maintenance, service and repair operations. Every working procedure that affects safety means shall only be carried out by competent persons according to Annex HH. Examples for such working procedures are:

- breaking into the refrigerating circuit;
- opening of sealed components;
- opening of ventilated enclosures.

## 10.2 Information on servicing

### 10.2.1 Checks to the area

Prior to beginning work on systems containing **flammable refrigerants**, safety checks are necessary to ensure that the risk of ignition is minimised. For repair to the **refrigerating system**, DD.4.3 to DD.4.7 shall be completed prior to conducting work on the system.

### 10.2.2 Work procedure

Work shall be undertaken under a controlled procedure so as to minimise the risk of a flammable gas or vapour being present while the work is being performed.

### 10.2.3 General work area

All maintenance staff and others working in the local area shall be instructed on the nature of work being



carried out. Work in confined spaces shall be avoided.

#### **10.2.4 Checking for presence of refrigerant**

The area shall be checked with an appropriate refrigerant detector prior to and during work, to ensure the technician is aware of potentially toxic or flammable atmospheres. Ensure that the leak detection equipment being used is suitable for use with all applicable refrigerants, i.e. non-sparking, adequately sealed or intrinsically safe.

#### **10.2.5 Presence of fire extinguisher**

If any hot work is to be conducted on the refrigerating equipment or any associated parts, appropriate fire extinguishing equipment shall be available to hand. Have a dry powder or CO<sub>2</sub> fire extinguisher adjacent to the charging area.

#### **10.2.6 No ignition sources**

No person carrying out work in relation to a **refrigerating system** which involves exposing any pipe work shall use any sources of ignition in such a manner that it may lead to the risk of fire or explosion. All possible ignition sources, including cigarette smoking, should be kept sufficiently far away from the site of installation, repairing, removing and disposal, during which refrigerant can possibly be released to the surrounding space. Prior to work taking place, the area around the equipment is to be surveyed to make sure that there are no flammable hazards or ignition risks. "No Smoking" signs shall be displayed.

#### **10.2.7 Ventilated area**

Ensure that the area is in the open or that it is adequately ventilated before breaking into the system or conducting any hot work. A degree of ventilation shall continue during the period that the work is carried out. The ventilation should safely disperse any released refrigerant and preferably expel it externally into the atmosphere.

#### **10.2.8 Checks to the refrigerating equipment**

Where electrical components are being changed, they shall be fit for the purpose and to the correct specification. At all times the manufacturer's maintenance and service guidelines shall be followed. If in doubt, consult the manufacturer's technical department for assistance.

*The following checks shall be applied to installations using **flammable refrigerants**:*

- the actual **refrigerant charge** is in accordance with the room size within which the refrigerant containing parts are installed;*
- the ventilation machinery and outlets are operating adequately and are not obstructed;*
- if an indirect refrigerating circuit is being used, the secondary circuit shall be checked for the presence of refrigerant;*
- marking to the equipment continues to be visible and legible. Markings and signs that are illegible shall be corrected;*
- refrigerating pipe or components are installed in a position where they are unlikely to be exposed to any substance which may corrode refrigerant containing components, unless the components are constructed of materials which are inherently resistant to being corroded or are suitably protected against being so corroded.*

#### **10.2.9 Checks to electrical devices**

Repair and maintenance to electrical components shall include initial safety checks and component inspection procedures. If a fault exists that could compromise safety, then no electrical supply shall be connected to the circuit until it is satisfactorily dealt with. If the fault cannot be corrected immediately but it is necessary to continue operation, an adequate temporary solution shall be used. This shall be reported to the owner of the equipment so all parties are advised.

Initial safety checks shall include:

- that capacitors are discharged: this shall be done in a safe manner to avoid possibility of sparking;
- that no live electrical components and wiring are exposed while charging, recovering or purging the system;

- that there is continuity of earth bonding.

### **10.3 Repairs to sealed components**

**10.3.1** During repairs to sealed components, all electrical supplies shall be disconnected from the equipment being worked upon prior to any removal of sealed covers, etc. If it is absolutely necessary to have an electrical supply to equipment during servicing, then a permanently operating form of leak detection shall be located at the most critical point to warn of a potentially hazardous situation.

**10.3.2** Particular attention shall be paid to the following to ensure that by working on electrical components, the casing is not altered in such a way that the level of protection is affected. This shall include damage to cables, excessive number of connections, terminals not made to original specification, damage to seals, incorrect fitting of glands, etc.

Ensure that the apparatus is mounted securely.

Ensure that seals or sealing materials have not degraded to the point that they no longer serve the purpose of preventing the ingress of flammable atmospheres. Replacement parts shall be in accordance with the manufacturer's specifications.

### **10.4 Repair to intrinsically safe components**

Do not apply any permanent inductive or capacitance loads to the circuit without ensuring that this will not exceed the permissible voltage and current permitted for the equipment in use. Intrinsically safe components are the only types that can be worked on while live in the presence of a flammable atmosphere. The test apparatus shall be at the correct rating. Replace components only with parts specified by the manufacturer. Other parts may result in the ignition of refrigerant in the atmosphere from a leak.

NOTE The use of silicon sealant can inhibit the effectiveness of some types of leak detection equipment.

Intrinsically safe components do not have to be isolated prior to working on them.

### **10.5 Cabling**

Check that cabling will not be subject to wear, corrosion, excessive pressure, vibration, sharp edges or any other adverse environmental effects. The check shall also take into account the effects of aging or continual vibration from sources such as compressors or fans.

### **10.6 Detection of flammable refrigerants**

Under no circumstances shall potential sources of ignition be used in the searching for or detection of refrigerant leaks. A halide torch (or any other detector using a naked flame) shall not be used.

The following leak detection methods are deemed acceptable for all refrigerant systems.

Electronic leak detectors may be used to detect refrigerant leaks but, in the case of **flammable refrigerants**, the sensitivity may not be adequate, or may need re-calibration.

(Detection equipment shall be calibrated in a refrigerant-free area.) Ensure that the detector is not a potential source of ignition and is suitable for the refrigerant used. Leak detection equipment shall be set at a percentage of the **LFL** of the refrigerant and shall be calibrated to the refrigerant employed, and the appropriate percentage of gas (25 % maximum) is confirmed.

Leak detection fluids are also suitable for use with most refrigerants but the use of detergents containing chlorine shall be avoided as the chlorine may react with the refrigerant and corrode the copper pipe-work.

NOTE Examples of leak detection fluids are

- bubble method,
- fluorescent method agents.

If a leak is suspected, all naked flames shall be removed/extinguished.

If a leakage of refrigerant is found which requires brazing, all of the refrigerant shall be recovered from the system, or isolated (by means of shut off valves) in a part of the system remote from the leak. Removal of refrigerant shall be according to Clause DD.9.

### **10.7 Removal and evacuation**

When breaking into the refrigerant circuit to make repairs – or for any other purpose – conventional

procedures shall be used. However, for **flammable refrigerants** it is important that best practice is followed since flammability is a consideration. The following procedure shall be adhered to:

- remove refrigerant;
- purge the circuit with inert gas (optional for A2L);
- evacuate (optional for A2L);
- purge with inert gas (optional for A2L);
- open the circuit by cutting or brazing.

The **refrigerant charge** shall be recovered into the correct recovery cylinders. For appliances containing **flammable refrigerants** other than **A2L refrigerants**, the system shall be purged with oxygen-free nitrogen to render the appliance safe for **flammable refrigerants**. This process may need to be repeated several times. Compressed air or oxygen shall not be used for purging refrigerant systems.

For appliances containing **flammable refrigerants**, other than **A2L refrigerants**, **refrigerants** purging shall be achieved by breaking the vacuum in the system with oxygen-free nitrogen and continuing to fill until the working pressure is achieved, then venting to atmosphere, and finally pulling down to a vacuum. This process shall be repeated until no refrigerant is within the system. When the final oxygen-free nitrogen charge is used, the system shall be vented down to atmospheric pressure to enable work to take place. This operation is absolutely vital if brazing operations on the pipe-work are to take place.

Ensure that the outlet for the vacuum pump is not close to any **potential ignition sources** and that ventilation is available.

### 10.8 Charging procedures

In addition to conventional charging procedures, the following requirements shall be followed.

- Ensure that contamination of different refrigerants does not occur when using charging equipment. Hoses or lines shall be as short as possible to minimise the amount of refrigerant contained in them.
- Cylinders shall be kept in an appropriate position according to the instructions.
- Ensure that the **refrigerating system** is earthed prior to charging the system with refrigerant.
- Label the system when charging is complete (if not already).
- Extreme care shall be taken not to overfill the **refrigerating system**.

Prior to recharging the system, it shall be pressure-tested with the appropriate purging gas.

The system shall be leak-tested on completion of charging but prior to commissioning. A follow up leak test shall be carried out prior to leaving the site.

### 10.9 Decommissioning

Before carrying out this procedure, it is essential that the technician is completely familiar with the equipment and all its detail. It is recommended good practice that all refrigerants are recovered safely. Prior to the task being carried out, an oil and refrigerant sample shall be taken in case analysis is required prior to re-use of recovered refrigerant. It is essential that electrical power is available before the task is commenced.

a) Become familiar with the equipment and its operation.

b) Isolate system electrically.

c) Before attempting the procedure, ensure that:

- mechanical handling equipment is available, if required, for handling refrigerant cylinders;
- all personal protective equipment is available and being used correctly;
- the recovery process is supervised at all times by a competent person;
- recovery equipment and cylinders conform to the appropriate standards.

d) Pump down refrigerant system, if possible.

e) If a vacuum is not possible, make a manifold so that refrigerant can be removed from various parts of the system.

f) Make sure that cylinder is situated on the scales before recovery takes place.

g) Start the recovery machine and operate in accordance with instructions.

- h) Do not overfill cylinders (no more than 80 % volume liquid charge).
- i) Do not exceed the maximum working pressure of the cylinder, even temporarily.
- j) When the cylinders have been filled correctly and the process completed, make sure that the cylinders and the equipment are removed from site promptly and all isolation valves on the equipment are closed off.
- k) Recovered refrigerant shall not be charged into another **refrigerating system** unless it has been cleaned and checked.

#### **10.10 Labelling**

Equipment shall be labelled stating that it has been de-commissioned and emptied of refrigerant. The label shall be dated and signed. For appliances containing **flammable refrigerants**, ensure that there are labels on the equipment stating the equipment contains **flammable refrigerant**.

#### **10.11 Recovery**

When removing refrigerant from a system, either for servicing or decommissioning, it is recommended good practice that all refrigerants are removed safely.

When transferring refrigerant into cylinders, ensure that only appropriate refrigerant recovery cylinders are employed. Ensure that the correct number of cylinders for holding the total system charge is available. All cylinders to be used are designated for the recovered refrigerant and labelled for that refrigerant (i.e. special cylinders for the recovery of refrigerant). Cylinders shall be complete with pressure-relief valve and associated shut-off valves in good working order. Empty recovery cylinders are evacuated and, if possible, cooled before recovery occurs.

The recovery equipment shall be in good working order with a set of instructions concerning the equipment that is at hand and shall be suitable for the recovery of all appropriate refrigerants including, when applicable, **flammable refrigerants**. In addition, a set of calibrated weighing scales shall be available and in good working order. Hoses shall be complete with leak-free disconnect couplings and in good condition. Before using the recovery machine, check that it is in satisfactory working order, has been properly maintained and that any associated electrical components are sealed to prevent ignition in the event of a refrigerant release. Consult manufacturer if in doubt.

The recovered refrigerant shall be returned to the refrigerant supplier in the correct recovery cylinder, and the relevant waste transfer note arranged. Do not mix refrigerants in recovery units and especially not in cylinders.

If compressors or compressor oils are to be removed, ensure that they have been evacuated to an acceptable level to make certain that **flammable refrigerant** does not remain within the lubricant. The evacuation process shall be carried out prior to returning the compressor to the suppliers. Only electric heating to the compressor body shall be employed to accelerate this process. When oil is drained from a system, it shall be carried out safely.